

NOTES

1. MATERIAL: MAHOGANY
2. SASH THICKNESS: 2.625"
3. FRAME THICKNESS: 1.25"
4. FRAME DEPTH: 6.5625"
5. STICKING: K&K
6. STOP: TRADITIONAL
7. GLASS: 1" INSULATED GLASS
8. WEATHERSTRIPPING: NO
9. FINISH: PRIMED (LATEX)

REV.	DESCRIPTION	DATE	DRAWN BY
A	INITIAL RELEASE	1/28/2025	BLG
B	CHANGED HEIGHT AND WIDTH	2/24/2026	BLG

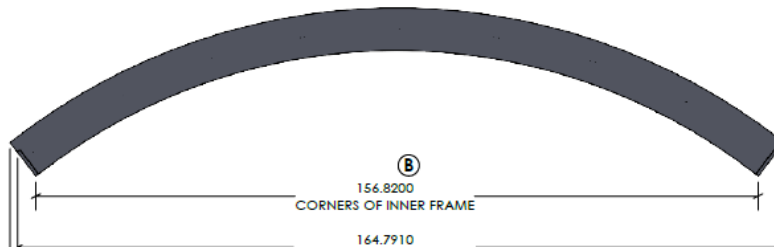
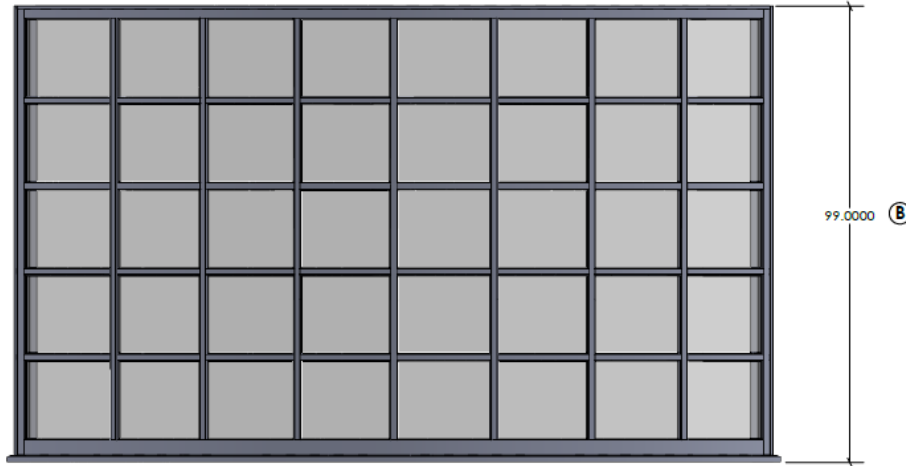

Approval Signature

Date
The signature (or AAN Stamp) on this print indicates the approval of the design, dimensions, and quantities shown. Authorization for this product to be manufactured is given.

*****ALL PARTS SHOWN ARE ADAMS STANDARD PROFILES*****
*****TWO DIMENSION REVISIONS ARE INCLUDED*****
*****ANY CHANGES TO PROFILES/PARTS WILL INCUR ADDITIONAL CHARGES*****

UNLESS OTHERWISE SPECIFIED
DIMENSIONS ARE IN INCHES



2225 Kerper Blvd.
Dubuque, IA 52001
563-690-1358 p

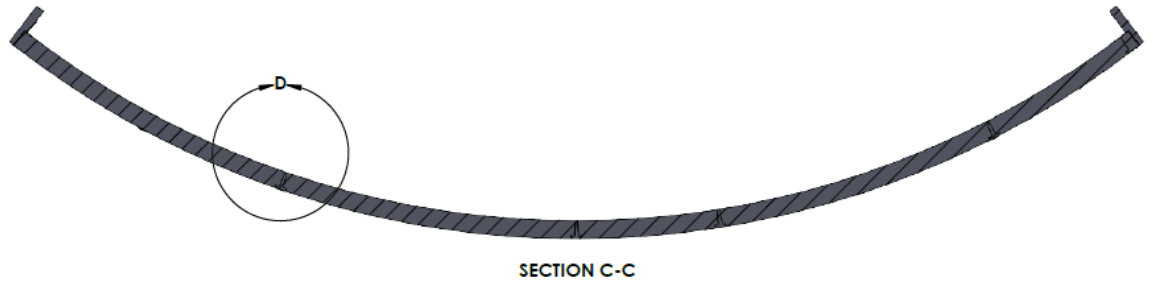
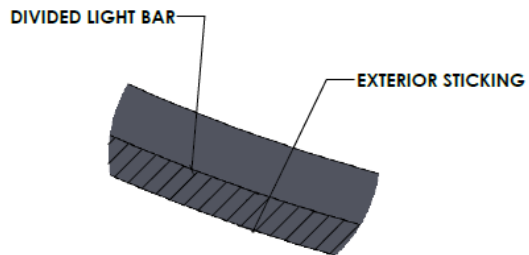
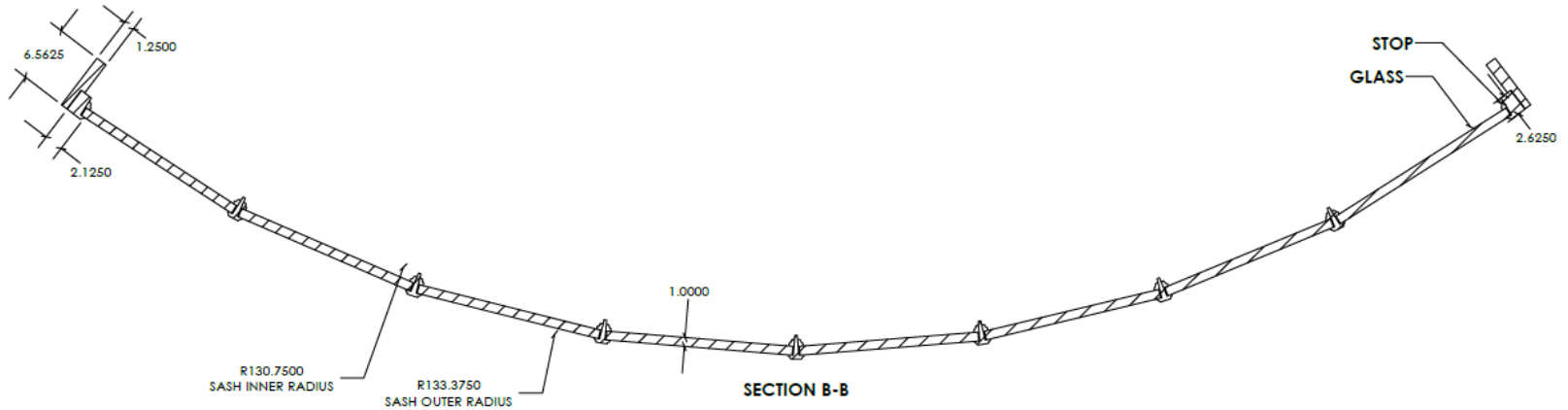

UNLESS OTHERWISE SPECIFIED
DIMENSIONS ARE IN INCHES

TOLERANCES:



2225 Kerper Blvd.
Dubuque, IA 52001
563-690-1358 p
563-557-8852 f

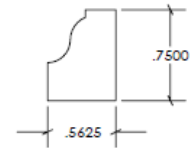
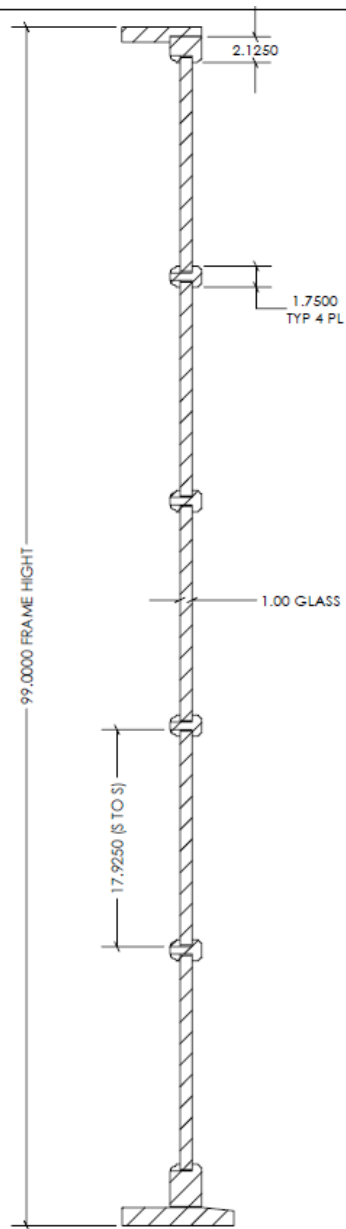
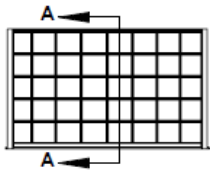

UNLESS OTHER
DIMENSIONS A
TOLERANCES:

SHEET 2 C